

09.362.72.15.0**BPW replacement brake caliper cpl. with brake pad BPW 8301, TSB 4312**

BPW replacement brake caliper (pre greased)
incl. guide pins and attachment parts

Type L

brake caliper without brake pad 05.362.72.05.0 (type plate)

No.	Name	Code number	Dimension	Quantity
323	Repair kit guide pins TSB item 325, 326, 328, 345, 346, 348, 373	09.801.07.61.1	for one axle side	1
324	Repair kit cylinder head screw + sealing cap TSB item 325, 335, 345	09.801.08.47.1	for one axle side	1
325	Cylinder head screw	03.340.12.32.0	M 16 x 1,5 x 103 - 10.9 / SW 14	1
326	Guide pin, long (fixed bearing)	05.001.00.41.0	Ø 17 / 26 / 37 x 123	1
328	Guide bush (fixed bearing)	03.112.33.13.0	Ø 37 / 41 x 73	1
334	Repair kit sealing cap item 335, 356	09.801.07.87.0	for one axle side	1
335	Sealing cap incl. item 336	05.001.00.45.0	M 49 x 1,5 / SW 14	2
336	O-ring	02.5679.97.40	Ø 45 x 2	2
345	Cylinder head screw	03.340.12.31.0	M 16 x 1,5 x 73 - 10.9 / SW 14	1
346	Guide pin, short (floating bearing)	03.001.00.35.0	Ø 17 / 26 / 36 x 70	1
348	Guide bush (floating bearing)	03.112.33.14.0	Ø 37 / 41 x 30	1
352	Repair kit seal for guide pins TSB item 335, 336, 354, 355, 356, 370, 373	09.801.07.62.0	for one axle side	1
354	Bellow	05.130.08.27.0	Ø 52 x 34	2
355	O-ring	02.5679.98.40	Ø 36 x 3,5	1
356	Ring	03.310.11.19.0	Ø 37 / 48 x 5,4	2
360	Repair kit tappet TSB item 362 - 365	09.801.07.63.1	for one axle side	1
362	Tappet	03.127.18.03.0		2
363	Bellow	05.130.07.07.0	Ø 26 / 55 x 62	2
364	Holding clamp	03.001.57.01.0	Ø 25 x 7	2
365	Dirt seal	03.121.30.15.0	Ø 55 x 1,5	2
370	Plug	02.3704.69.00	Ø 24 x 9	3
373	BPW ECO Disc Grease	02.1040.60.00	25 g	1
388	Repair kit brake pad TSB 4312 (BPW 8301) incl. item 370, 389, 394, 396 - 398	09.801.07.98.0	for one axle	1
389	Wearing plate TSB 4312	03.163.04.04.1	Only deliverable per kit 09.801.07.98.0!	6
390	Brake pad drilled TSB 4312 (BPW 8301)	05.092.90.20.1	Only deliverable per kit 09.801.07.98.0!	2
393	Repair kit brake retaining clip item 394 - 398	09.801.07.68.1	for one axle	1
394	Clamping spring	03.352.00.08.1	Only deliverable per kit 09.801.07.68.1 / 09.801.07.94.0 (TSB 3709) / 09.801.07.96.0 (TSB 4309) / 09.801.07.98.0 (TSB 4312)!	3

09.362.72.15.0

BPW replacement brake caliper cpl. with brake pad BPW 8301, TSB 4312



No.	Name	Code number	Dimension	Quantity
395	Pad holding bar	03.001.00.54.0	170 x 41,5 Only deliverable per kit 09.801.07.68.1!	3
396	Bolt	03.084.32.33.0	Ø 10 x 64,5 / 75	3
397	Washer	02.5404.10.04	Ø 10,5	3
398	Lock	02.3301.31.00		3
702	Wear sensor set for one axle	05.801.49.50.0		1

09.362.72.15.0

BPW replacement brake caliper cpl. with brake pad BPW 8301, TSB 4312

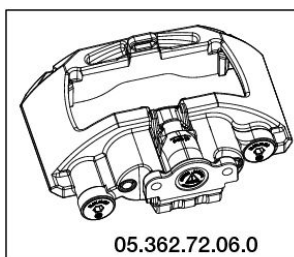

05.362.72.06.0

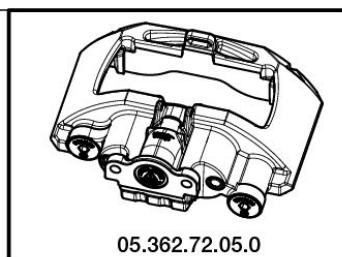

05.362.72.05.0

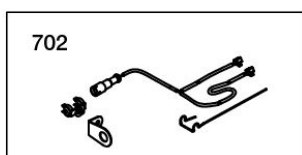
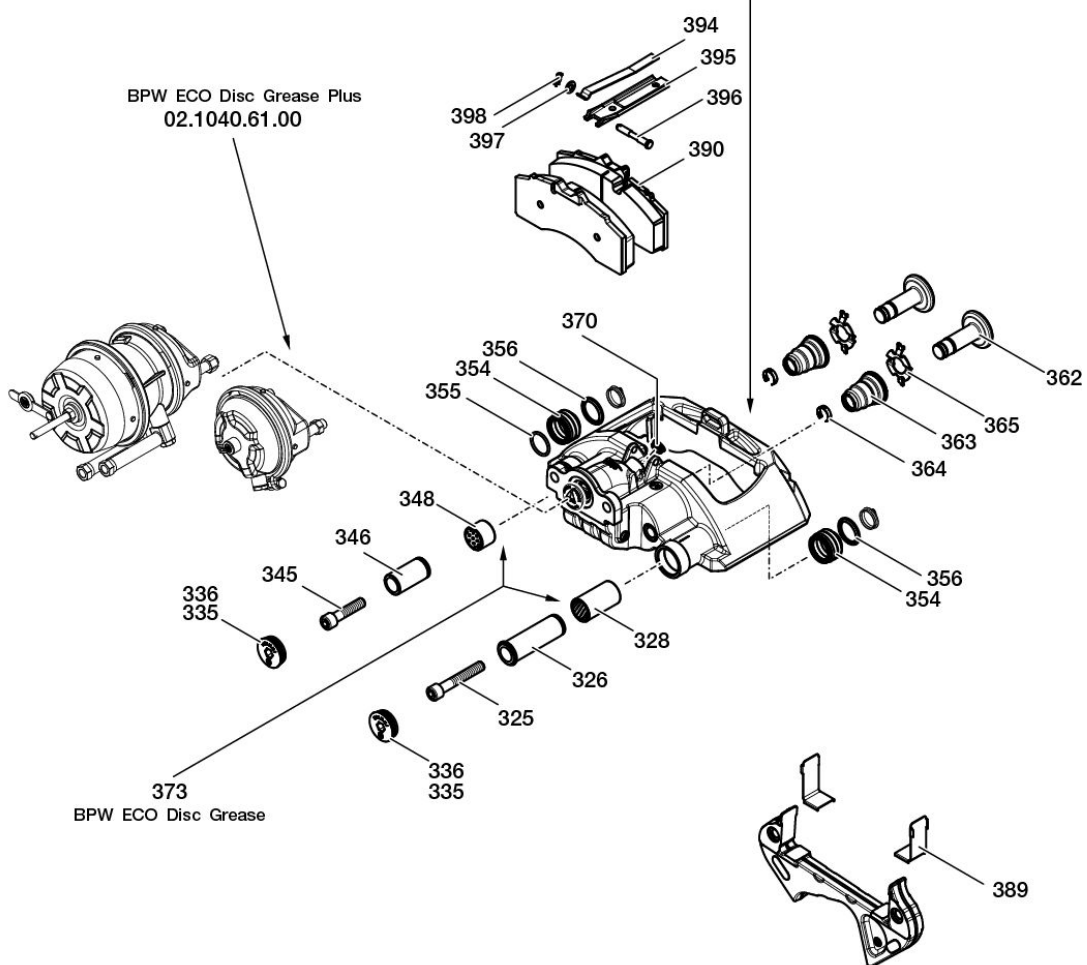

702